

GROSPERRIN S.A.

Zi de la louvière
14 route de besançon
25480 PIREY

Telephone 03-81-50-21-67
Fax : 03-81-53-41-96
Mail : Contact@grosperin.com

ACCESSOIRES POUR
FERMETURES DU BATIMENT

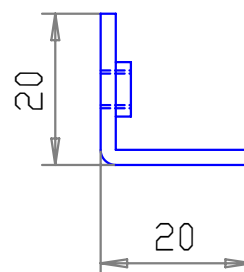
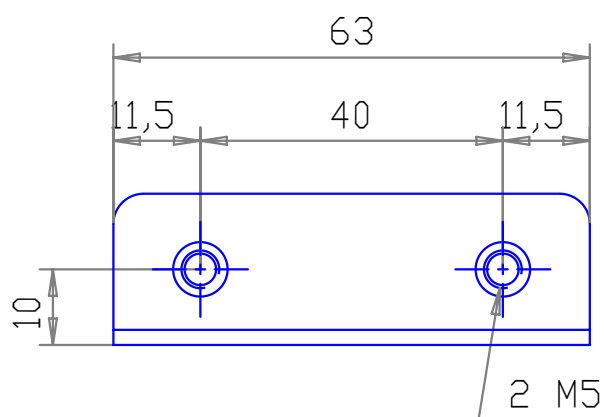

DESIGNATION

EQUERRE
N°1

MATIERE

ACIER ZN BLANC
ACIER ZN JAUNE
ACIER ZN EPOXY
INOX 304
INOX 316L

EPAISSEUR

20/10
20/10
20/10
20/10
20/10

REFERENCE

1960
1961
1962
1965
1966